

I. Mannopova, R. Mavlonova,  
N. Ibragimova

# TEKNOLOGIYA

Uliwma orta bilim beriw mektepleriniń  
1-klası ushin sabaqlıq

Qayta islangen hám toliqtırılǵan  
besinshi basılım

Ózbekstan Respublikası Xalıq bilimlendiriw  
ministrliği tárepinen  
tastıyqlanǵan

«O'QITUVCHI» BASPA-POLIGRAFIYALÍQ  
DÓRETIWSHILIK ÚYI

TASHKENT – 2019

UO'K: 373.3.016:331(075.2)

KBK 74.200.52

M 37

#### Pikir bildiriwshiler:

- Z. Shamsiyeva** – Respublikalıq bilimlendiriw orayı bólim baslıǵı;  
**M. Pulatova** – Tashkent qalasındaǵı 144-uliwma orta bilim beriw mektebiniń texnologiya pání muǵallimi;  
**D. Karimova** – Buxara qalasındaǵı 18-uliwma orta bilim beriw mektebiniń texnologiya pání muǵallimi.

#### SHÁRTLİ BELGILER:



– muǵallim oqıp beredi;



– toparda isleymiz;



– ámeliy jumis;



– pikirleymiz, juwap beremiz;



– ata-analar járdeminde tayarlaymız;



– óz betinshe jumis islew.

**Respublikà màqsetli kitàp qorı qàrjılàrı  
esàbinàn bàsıp shıǵàrdı.**

ISBN 978-9943-22-345-5

© I. Mannopova hám b.  
© «O'qituvchi» BPDÚ, 2019

# 1-sabaq. TEXNOLOGIYA PÁNI HAQQÍNDÁ TÚSINIK



Súwretke diqqat penen qarań!



Qala kóshelerinen biri súwretlengen. Súwrette nelerdi kórip tursız?

Onnan tábiyy hám insan tárepinen jaratılǵan zatlardı tabıń hám aytıń.

## INSAN JARATQAN DÚNYA



 Bul bólmedegi zatlar biz ushın ke-rek pe? Olardı kim tayarlağan? Qanday materiallardan tayarlanğan?



Súwretlerde kórsetilgen buyımlar qan-day materiallardan tayarlanğan? Insan bul zatlardı tayarlaw ushın materiallardı qay jerden alğan?

📖 Súwretlerge qarań. Olarda súwretlengen kásip iyeleri qanday jumıstı ámelge asırmaqta? Olardıń kásibin aytıń.



Hár bir kásip iyesine kerek bolatuǵın ásbaplardı tańlań.



📖 Texnologiya pání materialǵa tuwrı islew beriw usılların úyretedi.



# QÁWIPSIZLIK TEXNIKASÍ QAĖÍYDALARÍ

Qayshı menen islew qaĖıydası  
Qayshı qalay dúzilgen?

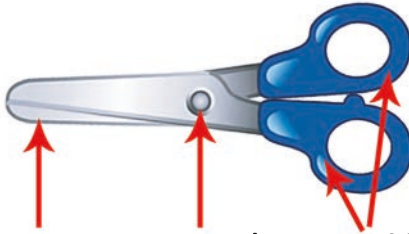

Júzi Burama shege Halqa



Ne ushin qayshını súwrette kórsetilgendey etip beriw kerek?



Siz ne dep oylaysız, ne ushin qayshı qapqa salıp qoyıladı?

Qayshı menen uzınsha qaĖazdan úshmúyeshlik hám kvadrat formaların qıyıń.



Jumis stoli





## Jelim menen islew qaǵıydası



Jelimdi ortadan shetke qarap súrtiń.

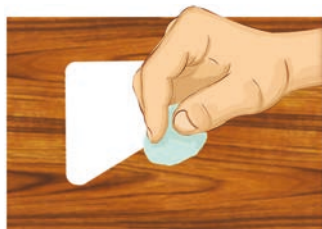

Artıqsha jelimdi sıyrıp alıń. Ústine zat qoyıp keptiriń.



Qılqálemdi paydalanıp bolǵannan soń, juwıp qoyıń. Jelim ıdıstı jabıq halında saqlań.



## 2- sabaq. «ALTÍN GÚZ» KÓRINISIN SOǴÍW

Tábiyat ráńbáreń hám gózzal. Insan dóretiwdi hárdayım tábiyattan úyrenen.



Qarań, tábiyiy maretiallardan tábiyat gózzallıǵın qalay jaratıw múmkin? Onda qanday tábiyiy materiallardan paydalanılǵan?



Oylap kóriń. Ne ushın tábiyattı qorǵaw kerek?





## JAPÍRAQ PENEN ISLEW

Japıraqlardı qalay keptiriw kerek?

Túsken japıraqlardı terip alıń.



Ústine zat qoyıp keptiriń.



Japıraqtı súwrette kórsetilgen tártipte jabıstırıń.

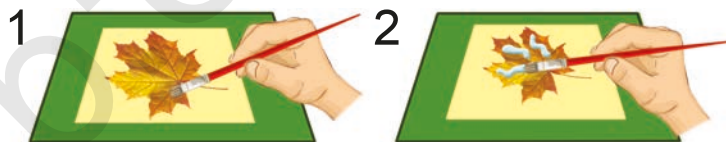



## ALTÍN GÚZ KÓRINISIN JAPÍRAQLARDAN PAYDA ETIW



Óz betińizshe japıraqlardan altın  
gúz kórinisin jasań.





### 3- sabaq. JAPÍRAQLARDAN NAĖÍS KOMPOZICIYASÍN JARATÍW

Súwrette japıraqlardan dúzilgen naĖís kompoziciyası berilgen. Salıstırın. Qaysı biri sizge unadı? Ne ushın?



**Kompoziciya** — súwretlewdi bir-birine salıstırılmalı belgili tártipte jaylastırıw.





Naǵıs dúziw ushın japıraqlardı saylap alıń hám qalay jaylastırıwdı oylap kóriń.

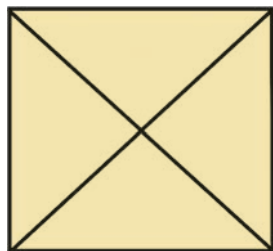

1

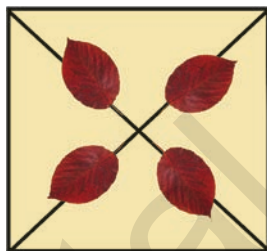

2



3



4



1

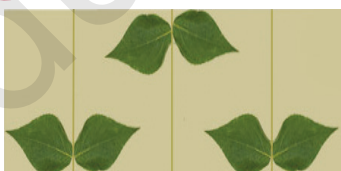

2



3

**Eslep qalıń!** Japıraqtı qayshı menen qıymań, onıń kereklesin tańlap alıń. Jabıstırıwda jelimdi japıraqtıń tamırlarına jaǵıń. Jumıstı tamamlaǵannan keyin ústine zat qoyıp keptiriń.



## 4 - sabaq. JAPÍRAQLARDAN QUSTÍN FORMASÍN SOGÍW



1



2



3



4



5



6

Ózińiz sogıwǵa háreket etip kóriń.





# TÁBIYIY MATERIALLARDAN KISHKENE QUSTÍN FORMASÍN SOĞÍW



1



2



3



4



5



## 5 - sabaq. JAPÍRAQLARDAN HAYWANLAR FORMASÍN SOĞÍW



Súwrette neler kórsetilgen? Ol qanday bólimlerden ibarat? Qoyandı soğıw ushın sizge qanday formadağı japıraqlar kerek boladı? Qoyan jasawdıń izbe-izligin baqlań hám ózińiz de jasań.



# SALÍSTÍRÍN

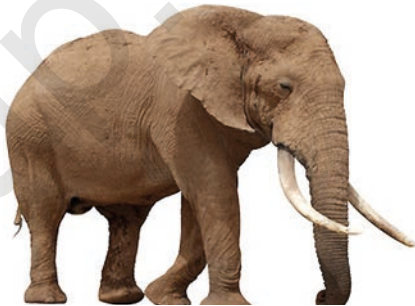





## 6- sabaq. JAPÍRAQLARDAN QUSLARDÍ SOGÍW



1



2



3



1



2



3



4



## 7- sabaq. TÁBIYIY HÁM HÁR TÚRLI MATERIALLARDAN QUSLARDÍ SOǒÍW



1



2



3



4

Ózińiz soǒıp kóriń.

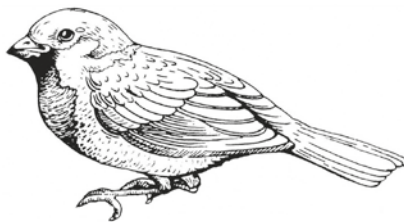



## 8- sabaq. TÁBIYIY HÁM HÁR TÚRLI MATERIALLARDAN KOMPOZICIYA JARATÍW



Ósimlikler tábiyattıń bir bólegi bolıp esaplanadı. Olar xudojnik-ustalardıń dóretiwshilik penen shuǵıllanıwı ushın hár túrli materiallar beredi. Xudojnik-ustalar ushın tábiyat qanday materiallardı beredi? Aytıp beriń.

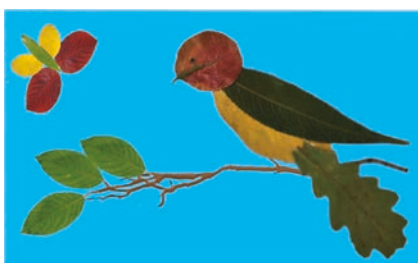

**Dıqqat!** Shaqa, japıraqlardı terekten úzbeń hám sındırmań. Tek ǵana jerge túskenin alıń. Tábiyattı qorǵań!



## 9 - sabaq. TUQÍMLARDÍ JÍYNAW HÁM SAQLAW



Jaz hám gúzde ósimlikler tuqım payda etedi. Súwrette berilgen tuqımlar qaysı ósimlikler tuqımı ekenin tabırń.

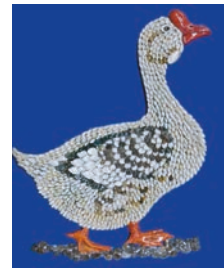

**Eslep qalıń!** Tuqımlardı seyilge shıq-qanıızda jıynap keliń, jaqsılap juwıń hám keptiriń. Sońınan ıdıslarda saqlań.



## 10- sabaq. TUQÍMLARDAN NAĖÍS SOĖÍW



Reńli kartonnan eni 3 sm, uzınlıǵı 9 sm bolǵan tuwrı tórtmúyeshlik formasın qıyıp alıń, qálem menen teń bóleklerge bólip shıǵıń. Onıń ishine naĖıs sızıp alıń, sońınan jelim yaki plastilin menen tuqımlardı naĖıs ústine jabıstırıp shıǵıń.

1



2



3



4





# ÓZIÍZ SOGÍP KÓRIÍN

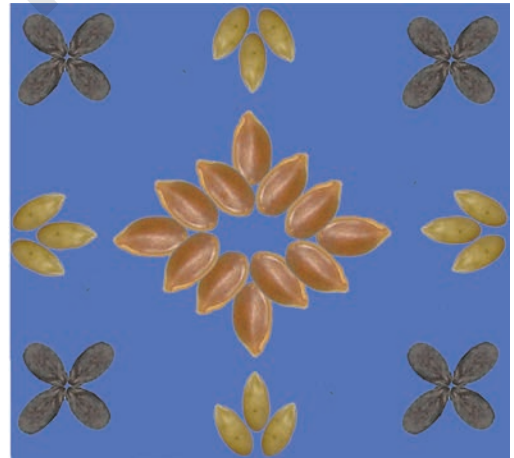
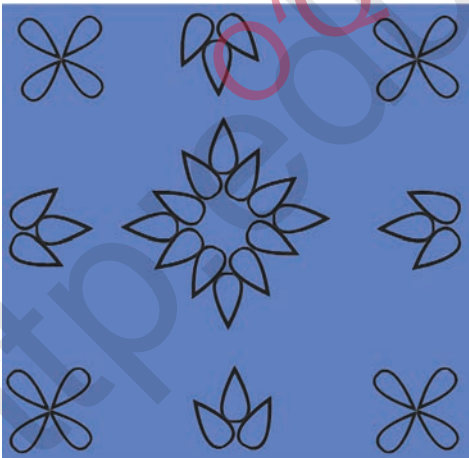
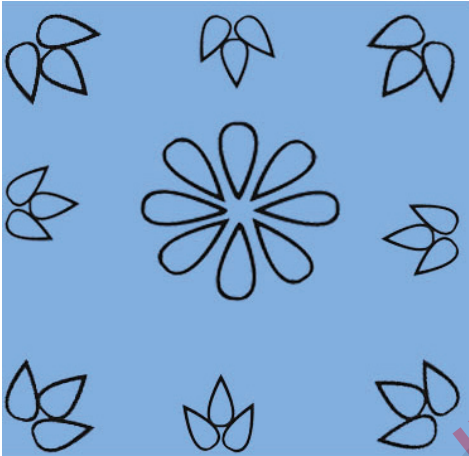



# 11- sabaq. BALÍQTÍN FORMASÍN SOǴÍW



1

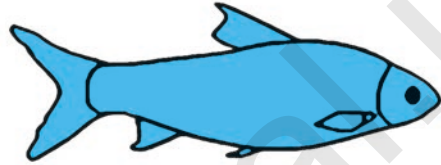

2

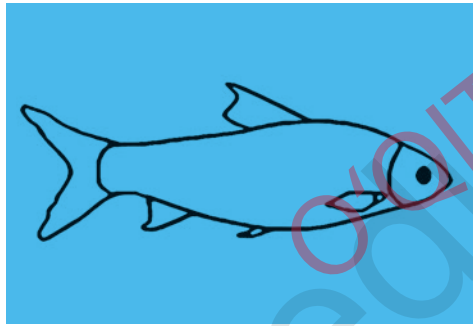

3

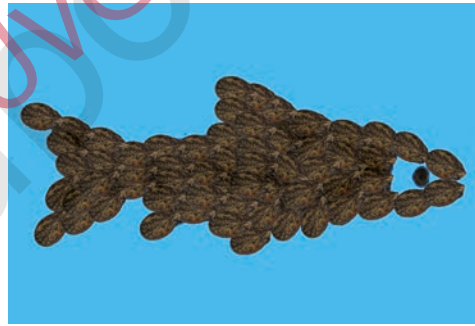

4

Ózińiz soǵıp kóriń.

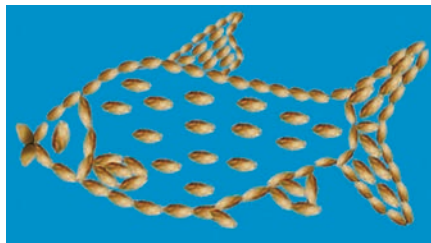



## 12- sabaq. ROMASHKA GÚLIN SOǒÍW



1



2

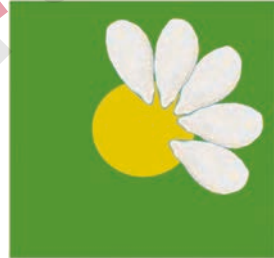

3

Ózińiz soǒıp kóriń.







## ÓZIÑIZDI TEKSERIÑ



Muğallimiñiz hám ata-anañızdı quwandırıñ. Neni biliwiñizdi, orınlay alıwiñizdi kórsetiñ. Durıs juwaptı tañlañ.

Tábiiy materiallar menen islewde qanday ásbaplardı paydalanasız?



Tábiiy bolmağan material degen ne?



Qaysı súwrette nağıs durıs jasalğan?



Klaslaslarıñız benen juwaplardı talqılañ.



## QAĞAZ HÁM KARTON MENEN ISLEW

**Qağaz** — bul bizge hárdayım kerek bolatuǵın material bolıp esaplanadı.



Siz qağazdan islengen qanday buyımlardı bilesiz? Súwretke jaqsılap qarań. Bul buyımlar kimge hám ne ushin kerek?



Kartondı reńli qağazlarıńız arasınan tabıń. Qanday uqsaslıq bar? Hár túrli qağazlardı uslap kóriń. Neni baqladıńız? Qağazdıń ayırmashılıqların aytıń.

## 13-sabaq. QAĞAZ HÁM ONÍŇ TÚRLERI



Jazıw qağazı.



Gazeta qağazı.



Karton.



Súwret qağazı.



Sawğanı oraytuğın qağaz.

## QAĞAZ BENEN ISLEW



Úlgi boyınsha belgilew.



Qıyıw.



Qıyıp alıw.



Oraw.

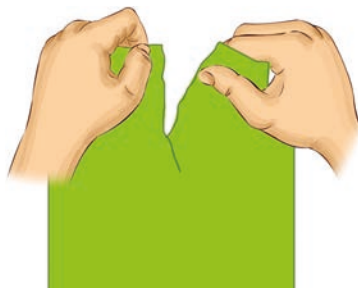

Jırtıw.

Siz qalay oylaysız, qağaz benen jáne ne islew múmkin?

# QAĞAZDÍ BÚKLEW HÁM QÍYÍW USÍLLARÍ

1



Búkłeń.

Qıyıń.

2



Búkłeń.

Qıyıń.

3



Búkłeń.

Qıyıń.

4



Búkłeń.

Orań.



## KISHI USTA OYINI

Gózzallıqtı birgelikte jaratamız.  
Siz ushın tómendegiler kerek boladı:



Endi siz qaǵaz benen islew qaǵıyda-  
ların bilip aldıńız.

Qaǵazdan zatlar soǵıwda olardan pay-  
dalanıń.



Qaǵaz betinen neler payda boldı?

Tapqırlıǵıńızdan paydalanıp, berilgen  
formalardan qanday da bir kórinis jasap  
kóriń.

Tómendegiler nege uqsaydı?

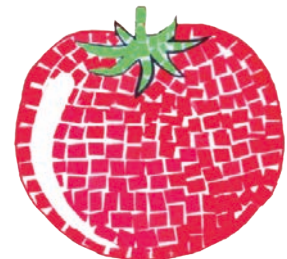
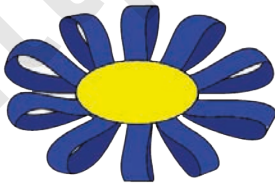



# QAYÍQ SOĞÍW

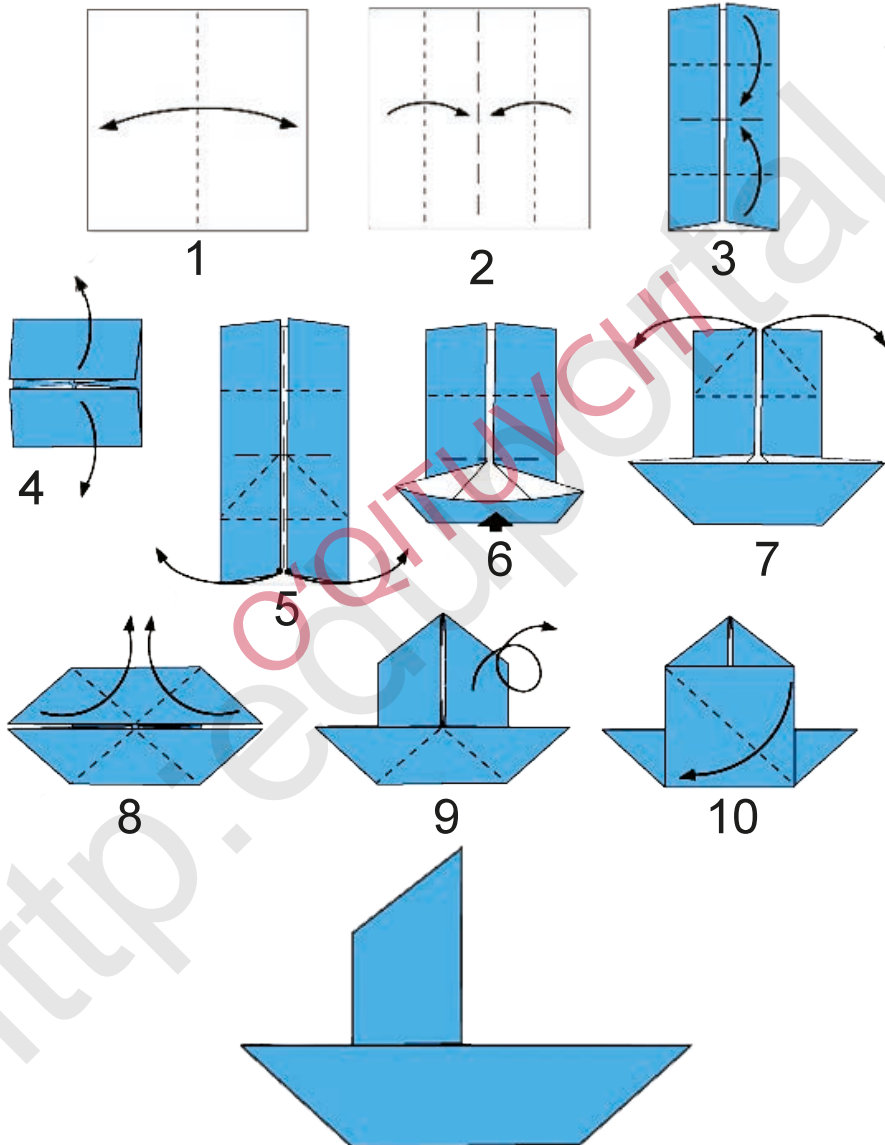



# 14 - sabaq. KITAP USHÍN BELGI SOǒǒIW



1

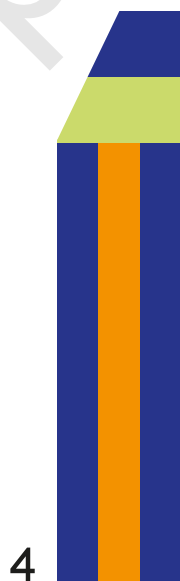





1

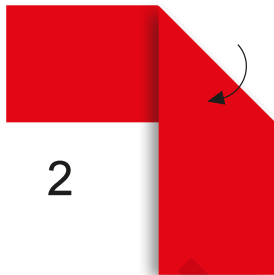

2

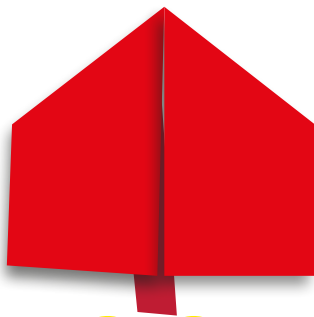

3



4

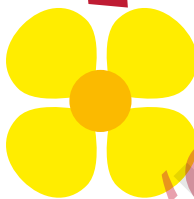

5



6



7

Kitap ushın belgi ne maqsette soǵıladı?

Ol sizge ne ushın kerek boladı?



## 15- sabaq. QAĞAZDAN KÚSHIK SOĞIW

Qağazdı búklew texnikası tiykarında formalar soğıw óneri **origami** dep ataladı.

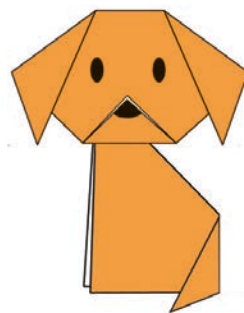
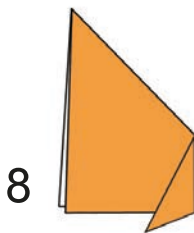
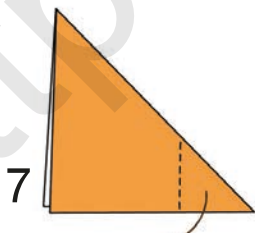
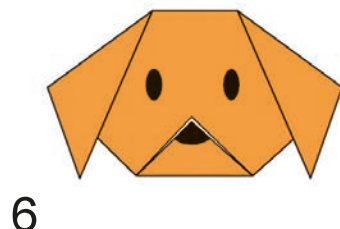
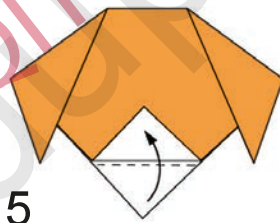
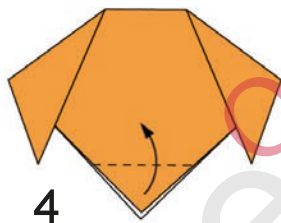
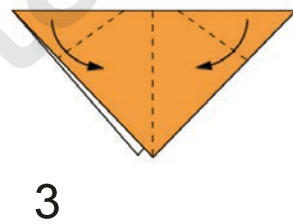
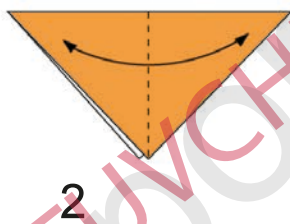
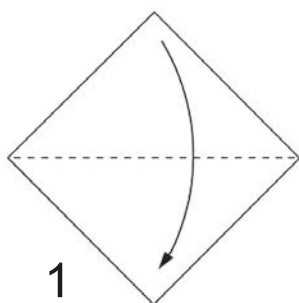



## JAÑA JÍL USHÍN OYÍNSHÍQLAR TAYARLAW

**1-yanvardan** Jaña jil baslanadı. Bayram bezew zatların soǵıp, klass bólmemizdi bezeń.

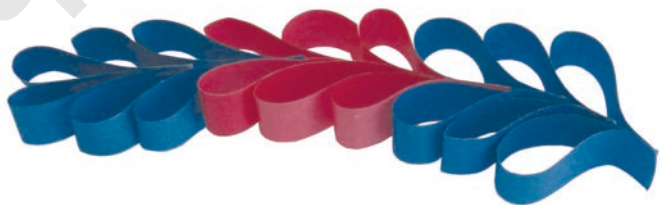
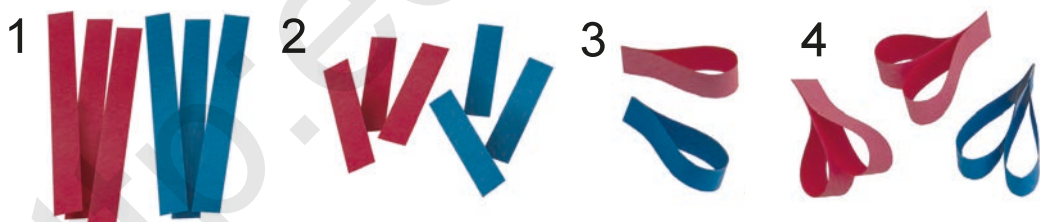
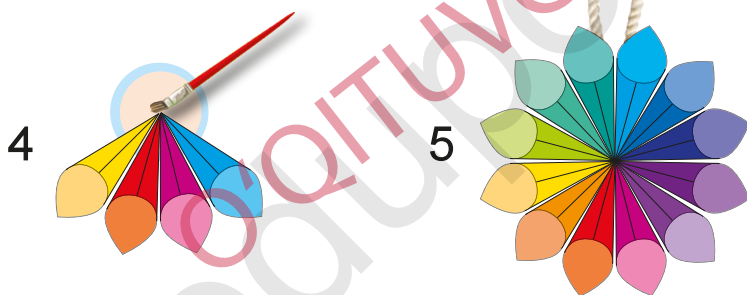
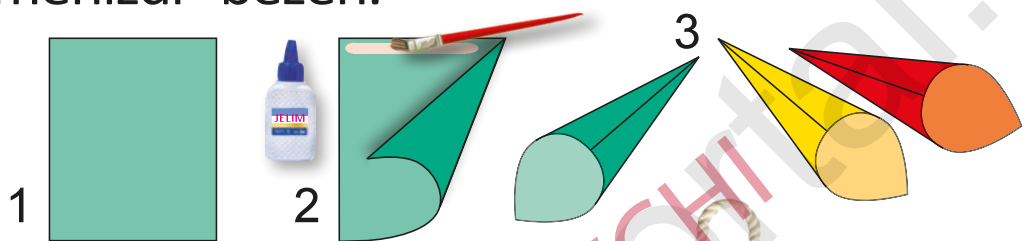



# 16 - sabaq. BAYRAMLAR USHÍN NÍQAPLAR TAYARLAW

## Qoyanniń nıqabın soǵıw

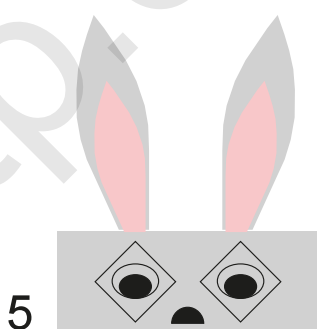
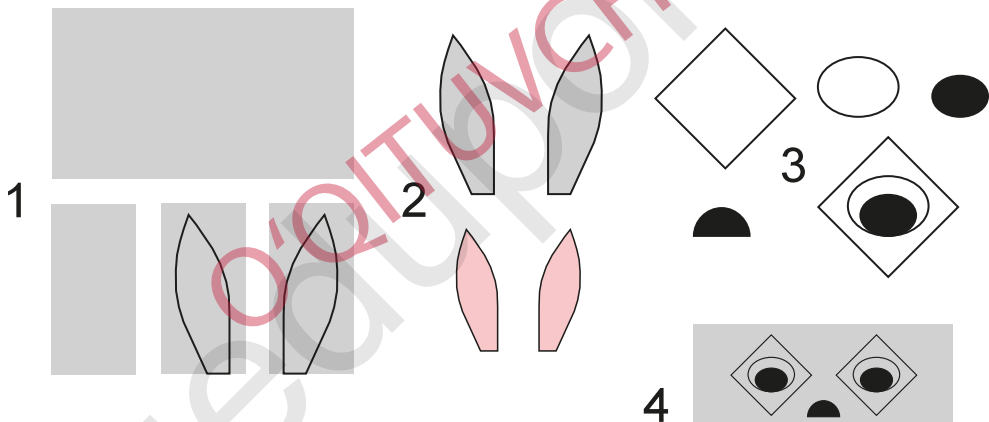



## Ayıw nıqabın soǵıw



Qaǵazdı ekige búklep, úlgi tiykarında ayıwdıń bas bólimin sızıp alıń.



Sızıq boylap qıyıń. Arasın ashıń, qálem menen qasların hám tumsıǵın sızıń hám boyañ.



## 14-yanvar — «Watan qorgawshilari kuni»

Armiyamiz – biziń tinishligimiz tiregi. Kúshli, batır áskerlerimiz jerde, suwda, hawada xızmet etedi.



 Olardıń xızmeti qanday texnika menen baylanıslı?



Shańaraǵızda xızmet etken yamasa xızmet etip atırǵanlar bar ma? Olar ushın sawǵalar tayarlań.



## 17 - sabaq. QAĞAZDAN OYÍNSHÍQLAR SOĜÍW

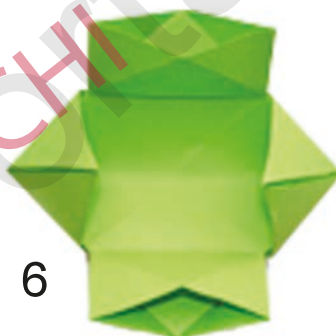
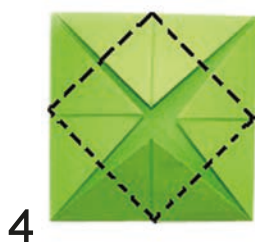
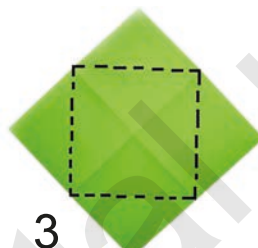
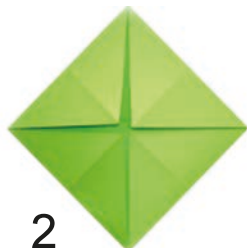
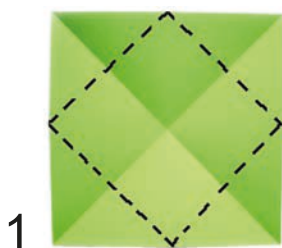

Soqqan kemeńizden siz qalay paydalanbaqshıńız? Onı kimge sawǵa etiw múmkin?



# Ushatugin planer soqiw

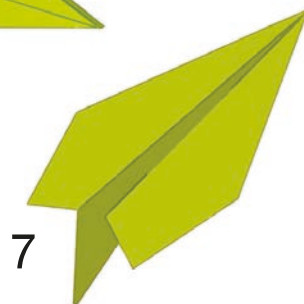
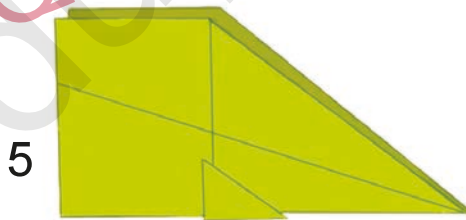
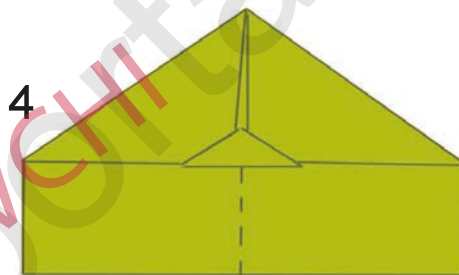
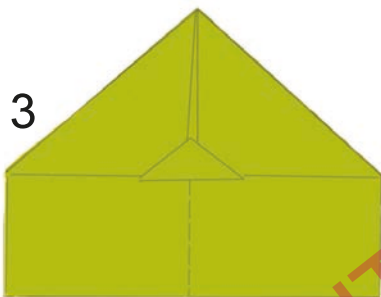
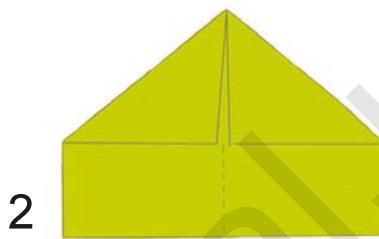



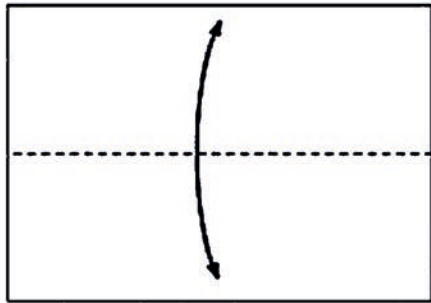

1

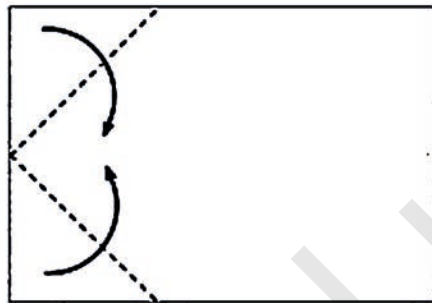

2

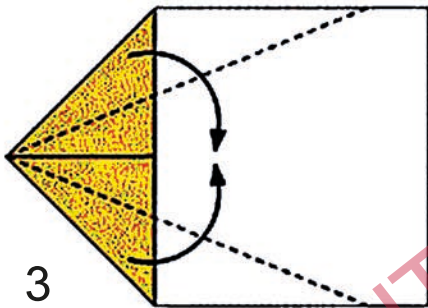

3

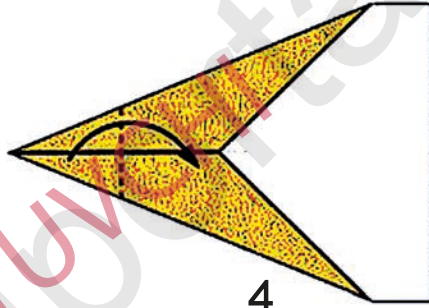

4

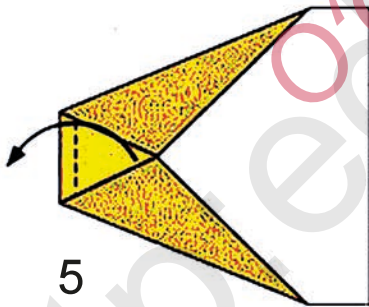

5

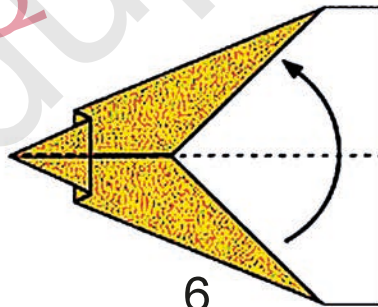

6



7

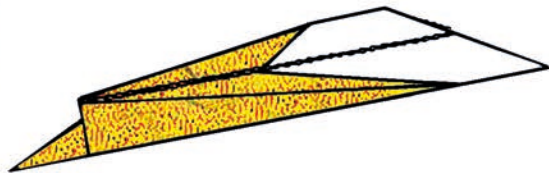



# 18-sabaq. QÍS KÓRINISIN APPLIKACIYA USÍLÍNDÁ ISLEW



1

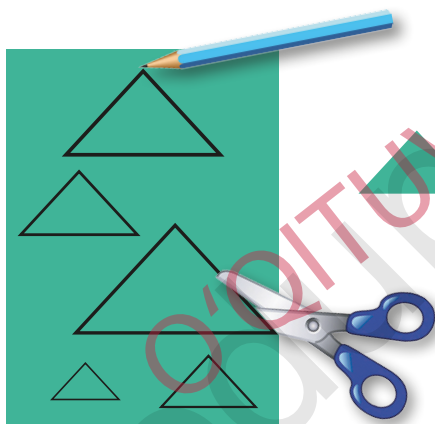

2

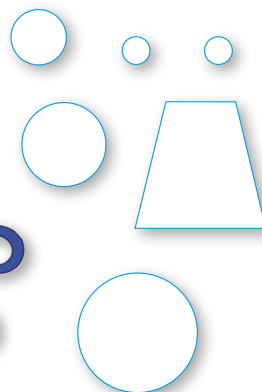
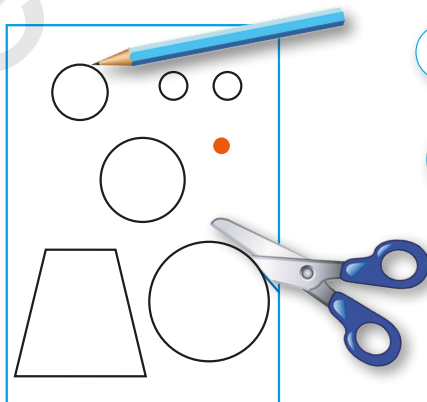

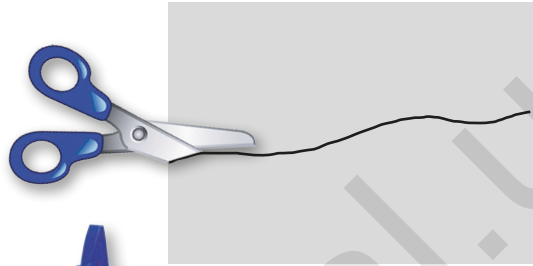
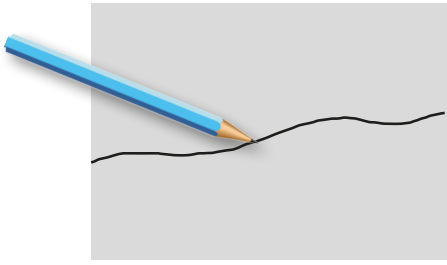

3



4

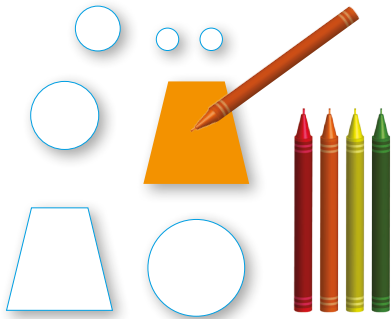

5



6





# 19-sabaq. REŃLI QAĞAZDAN JANÍWARLARDÍŃ FORMASÍN QURASTÍRÍW-SOĞÍW

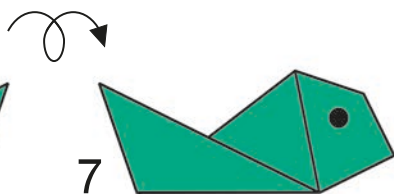
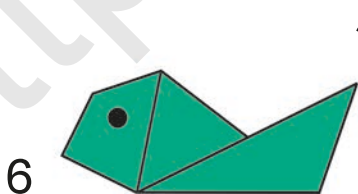
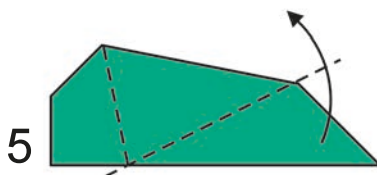
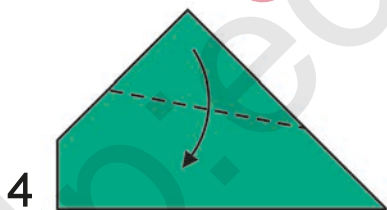
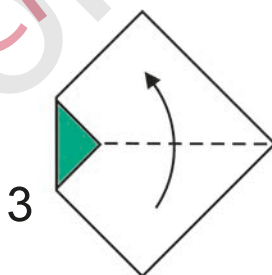
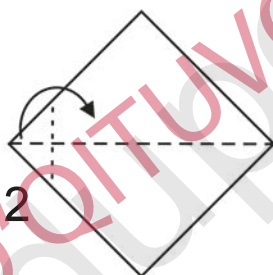
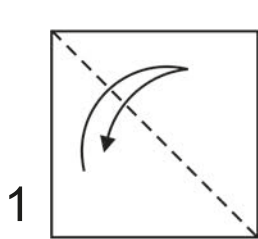



1



2



3



4

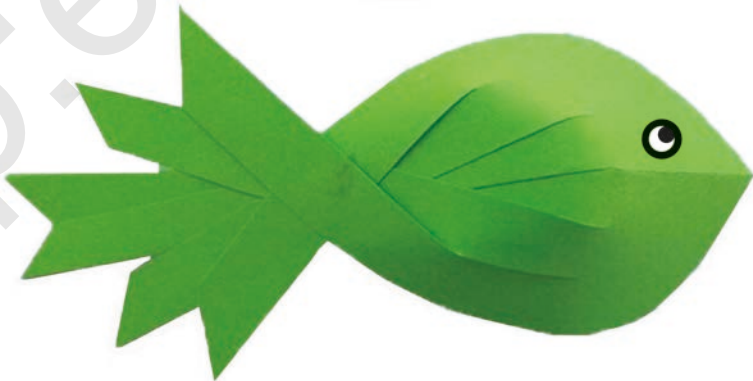



# 20-sabaq. QAĞAZDAN TÚLKI-NIŇ FORMASÍN QURASTÍRÍW-SOǒÍW

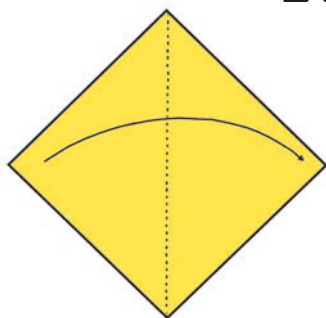

1



2

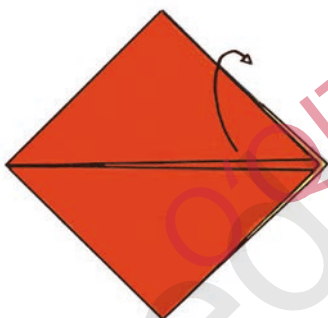

3

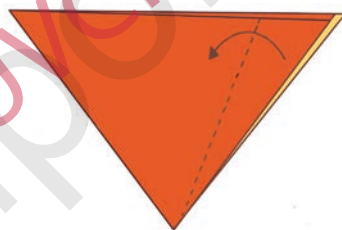

4

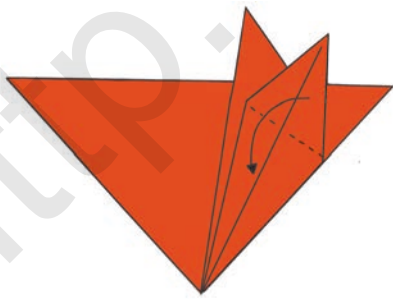

5

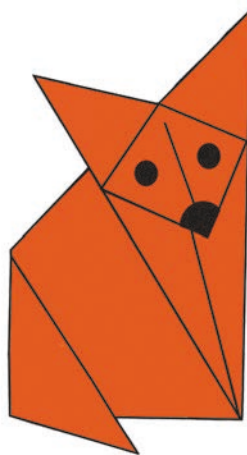



# QAĞAZDAN PÍSHÍQTÍN FORMASÍN QURASTÍRÍW-SOĞÍW

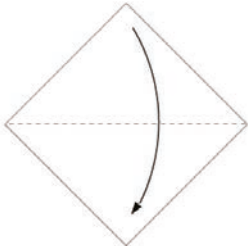

1

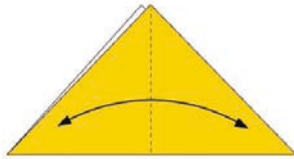

2

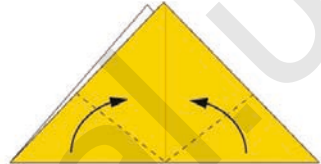

3

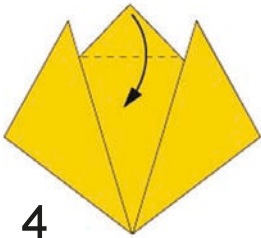

4



5



6



7



8



9

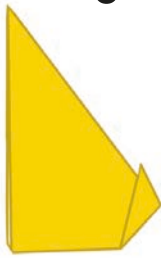

10







## 21 - sabaq. MOZAIKA HAQQÍNDÁ TÚSINIK



Mayda qaǵaz bólekshelerin qalay jabıstırıw múmkin?

Quslar qalay súwretlengen? Nesi menen uqsas?



**Mozaika** — mayda bólekshelerden dúzilgen naǵıs hám súwret bolıp esaplanadı.

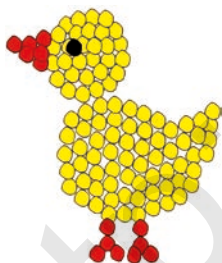

Oylap kóriń, mozaika jaratıw ushın qanday qaǵaz qolaylı boladı? Juqa qaǵaz ba yaki qalıń qaǵaz ba? Qaǵaz bólekshelerin qalay jabıstırıw kerek eken?



## 22- sabaq. MOZAIKA USÍLÍNDA PALÍZ ÓNIMLERINIŇ FORMASÍN SOĖÍW

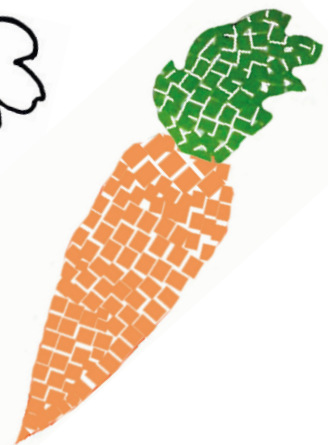
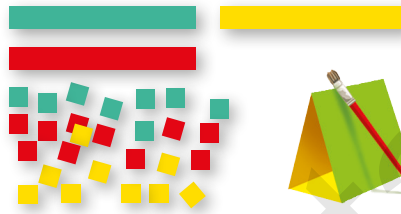

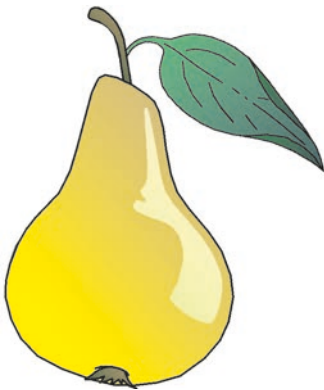
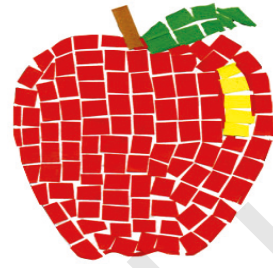

Salfetka qaǵazın mayda etip qıyıp, domalaq formaǵa keltiriń hám onı sızıp alǵan úlǵıńızdiń ústine bir tegiste jabıstırıń.

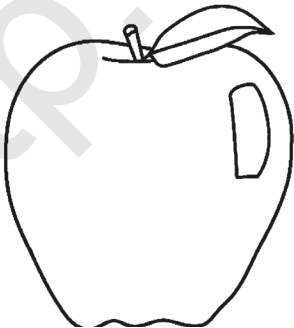

## 23- sabaq. DIZAYNERLIK KÁSIBI

**Dizayn** — bul oylaw, sızıw, joybarlaw.  
**Dizayner** — joybarlawshı xudojnik bolıp tabıladı.

**Dizaynerlik kásibi** — kórkem óner estetikası boyınsha qánigeli xudojnik.

Dizaynerlik qızıqlı kásip. Bul kásiptegi insanlar hárdayım jańa buyımlardı oylap tabadı. Bular úy úskeneleri, kiyimler, texnikalıq ásbaplar hám júdá kóp basqa buyımlar bolıwı múmkin. Súwrette berilgen buyımlardıń dúzilisi hám bezetiliwindegi ayırmashılıqlardı tabıń.





# 8-MART BAYRAMINA QUTLIQLAWNAMA TAYARLAW

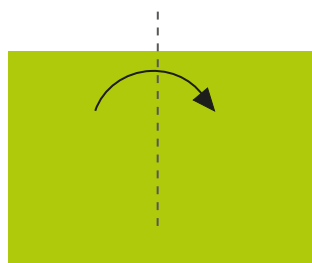

1

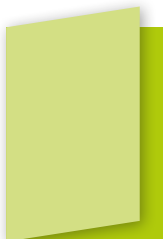

2

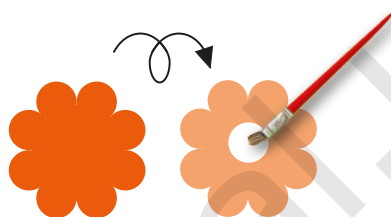

3

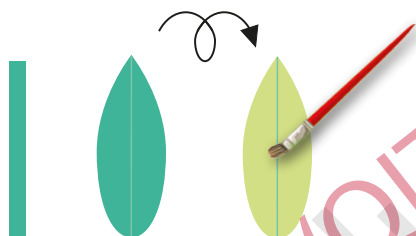

4



5

6



7





# 24-sabaq. NAWRÍZ BAYRAMÍNA QUTLÍQLAWNAMA TAYARLAW

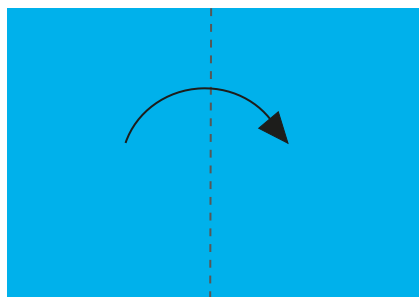

1



2

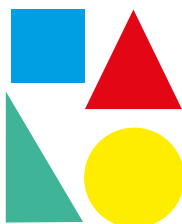

3



4

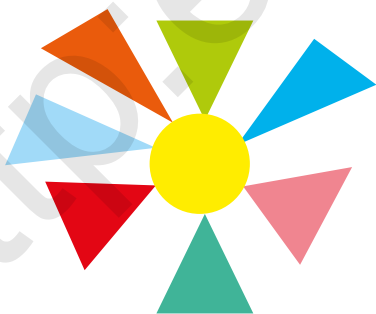

5



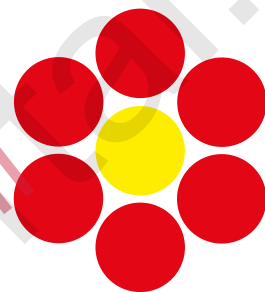
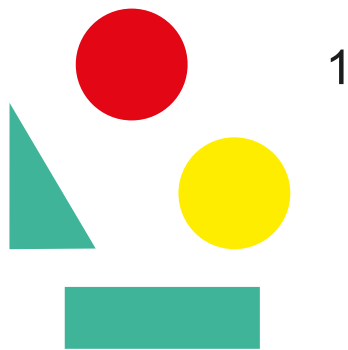



## 25- sabaq. GEOMETRIYALÍQ FORMADAGÍ QAĞAZLARDÍ QÍYÍW USÍLLARÍ

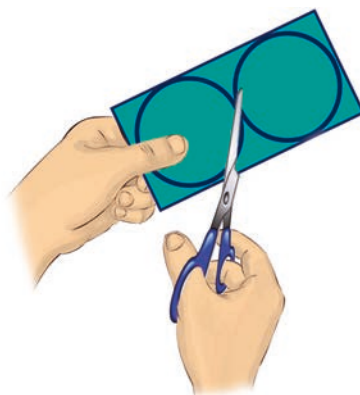
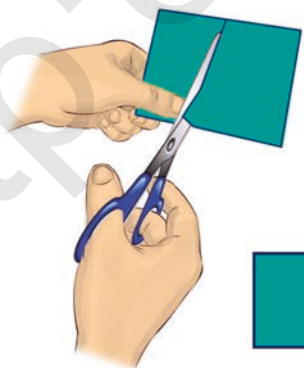
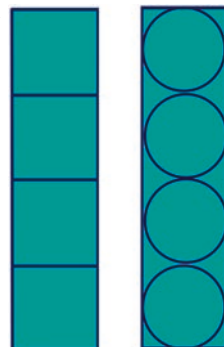
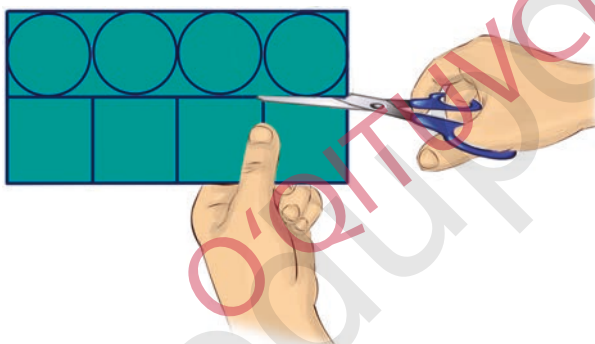
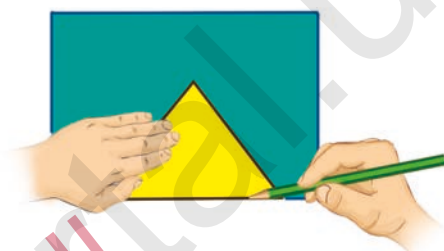





## 26 - sabaq. GEOMETRIYALÍQ FIGURADAGÍ QAĞAZLARDAN HÁR TÚRLI HAYWANLARDÍN FORMASÍN SOĞÍW

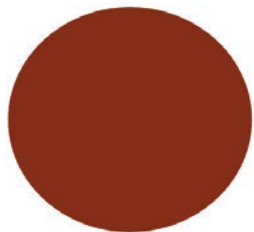

1



2



3

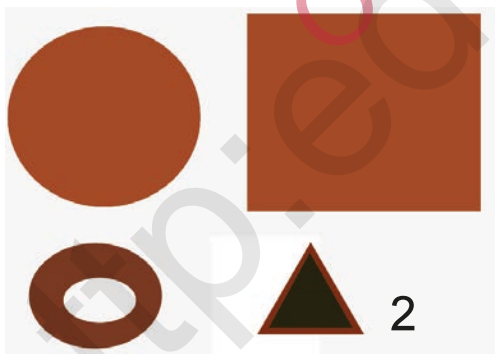

1



3

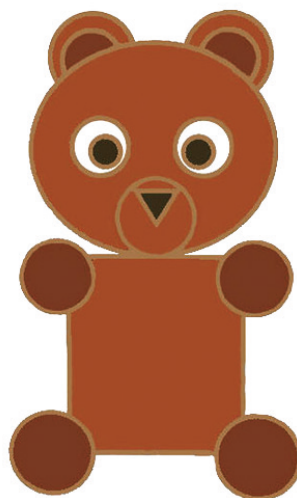



# GEOMETRIYALÍQ FIGURADAĞÍ QAĞAZLARDAN QUSLARDÍN FORMASÍN SOĞÍW

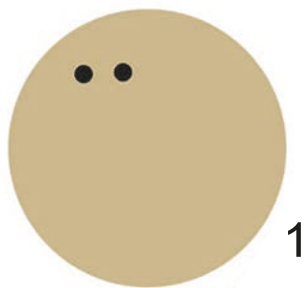



## HAYWANLAR KÓRINISIN BAQLAÑ HÁM SOĖÍP KÓRIÑ

Súwrette qanday haywanlar súwret-  
lengen? Olardı soĖiw ushın siz qanday  
formadaĖı qaĖazlardan paydalanıwıñız  
lazım?

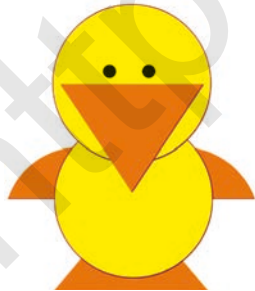



# 27 - sabaq. GEOMETRIYALÍQ FORMADAĞÍ QAĞAZLARDAN MASHINA QURASTÍRÍW- SOĞÍW

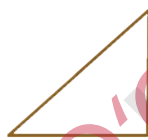
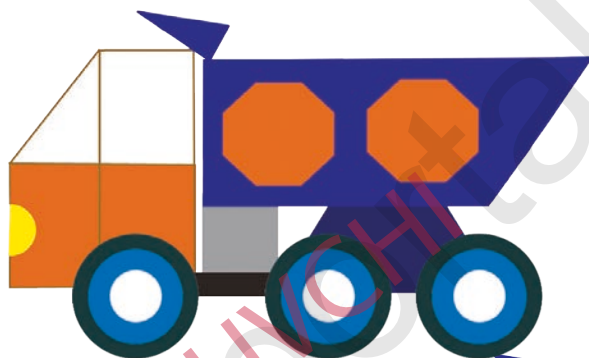



## BAQLAÑ HÁM SOĞÍP KÓRIÑ

Súwrette qanday mashinalar súwretlengen? Usı súwretlerge qarap óziñiz mashinaniñ formasın óz betiñizshe soğıp kóriñ.

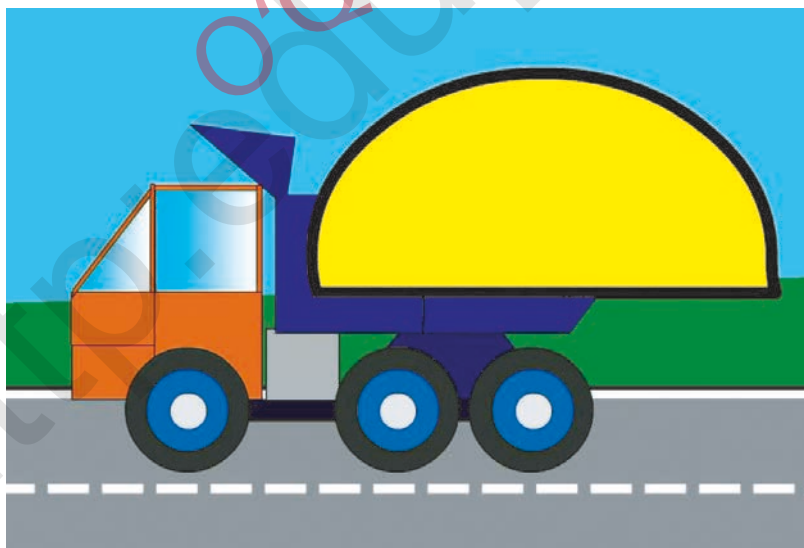
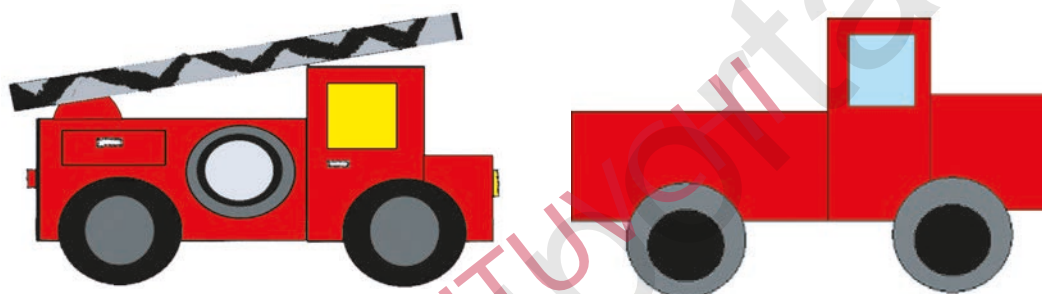



## 28- sabaq. MIYWE HÁM PALÍZ ÓNIMLERIN SIMMETRIYALÍ FORMALARDAN SOǒÍW

Súwretke diqqat penen qarań. Qaǵaz ekige búklengennen keyin qanday jumıs ámelge asırıladı?



Almanıń formasın qaǵazdı ekige búklew jolı menen tayarlań.



Uzınsha formadan almurttıń formasın qıyıń.

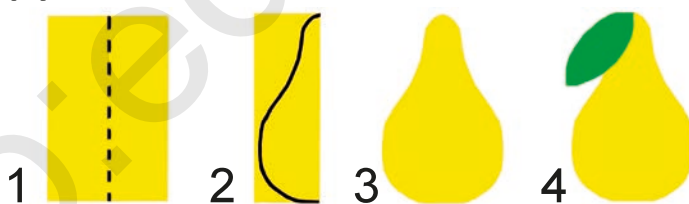

Qaǵazdı búklep, alshanıń formasın tayarlań.

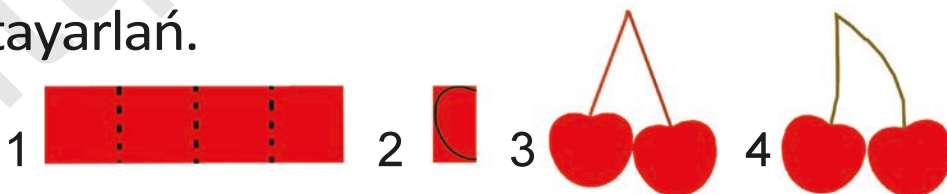

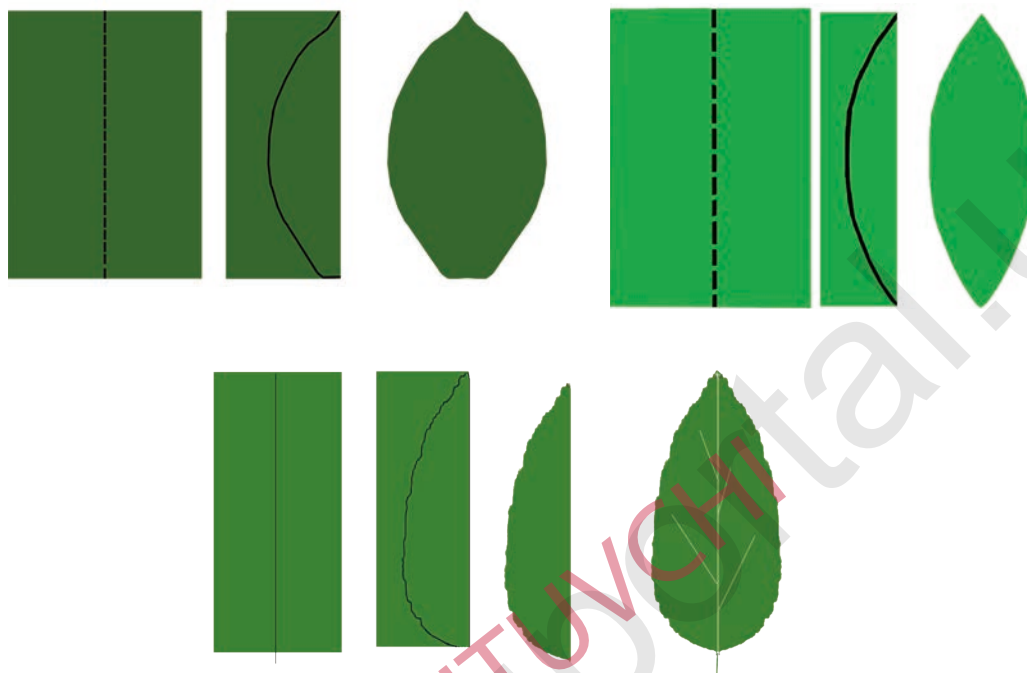

Tayarlağan miywelerińizdi tarelkaǵa salıń.

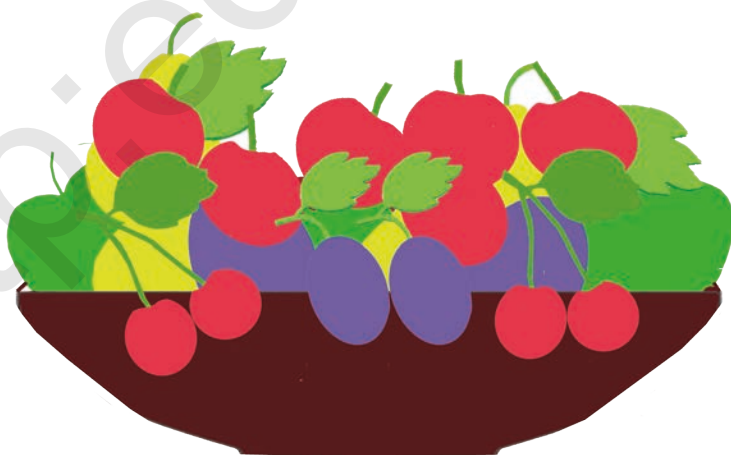



## 29-sabaq. QURÍLÍSSHÍ KÁSIBI

Kóshege shıqsanıız, úy, mektep, baqsha hám dúkánlardı kóresiz. Bul imaratlardı qurıwda gerbish óriwshi, sıbawshı, aǵash ustası, boyawshı hám basqa kásip iyeleri birgelikte miynet etken.



Aytıńshı, kim qanday jumıs islemekte?

Olardıń kásibi qalay ataladı?





# JAYDÍŃ MAKETIN SOǒÍW

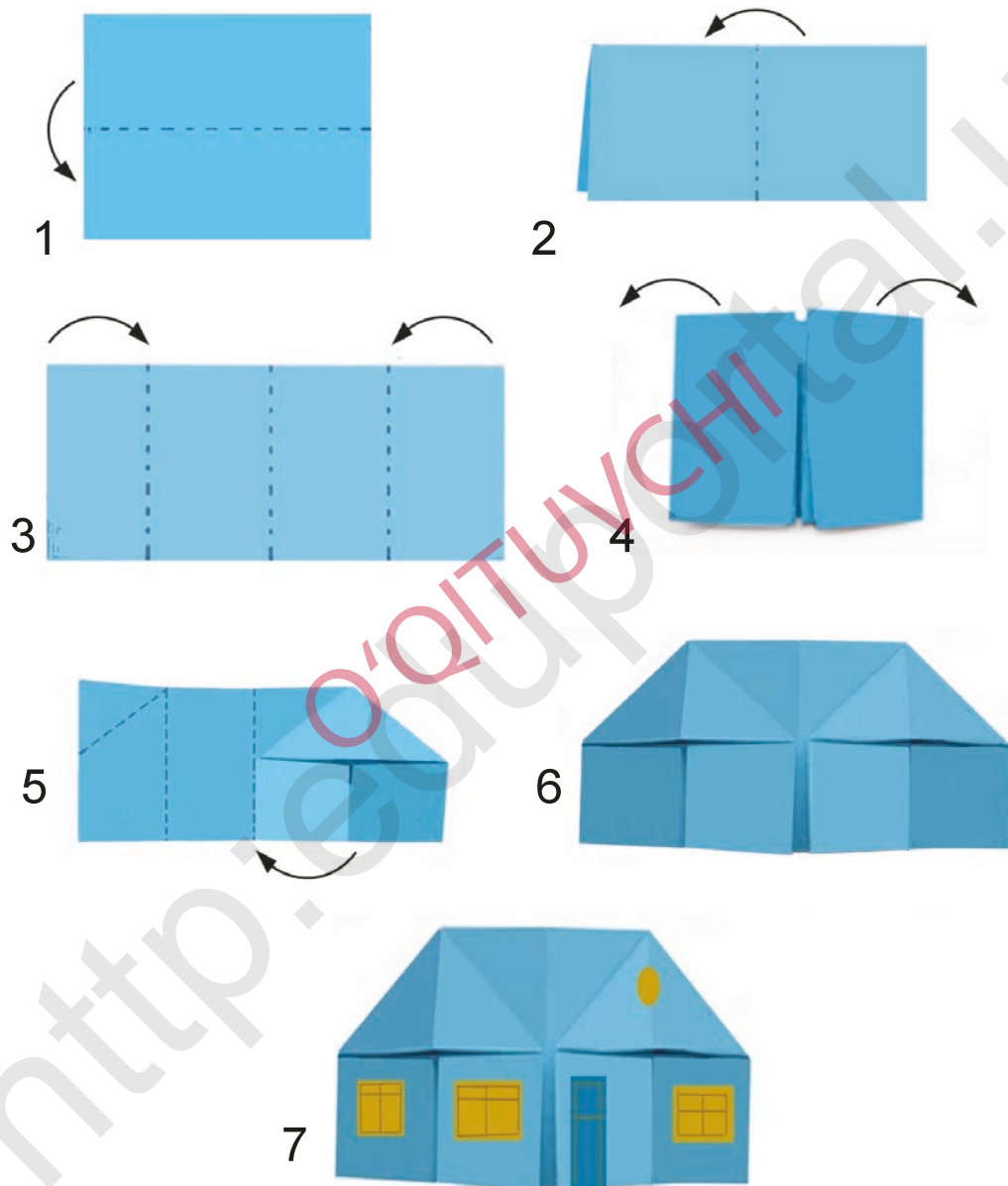



Soğıwga háreket etip kóriń.



1



2



3



4



5



6



7



8



# 30- sabaq. QAĞAZDAN «SEBETDEGI GÜLLER»DI QURASTIRIW-SOĞIW



1



2



3



4



5



6



7



1



2



3



4



5



6



7



8



# 31- sabaq. QAĞAZDAN BÚKLEW USÍLÍNDÁ HAYWANLAR, QUSLARDÍŇ FORMASÍN SOĖÍW

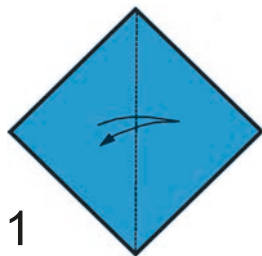

1

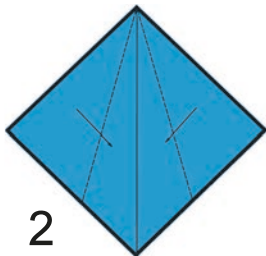

2

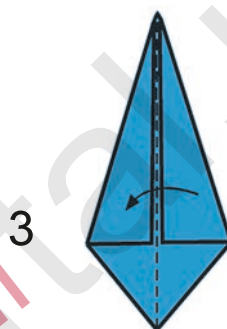

3



4



5



6

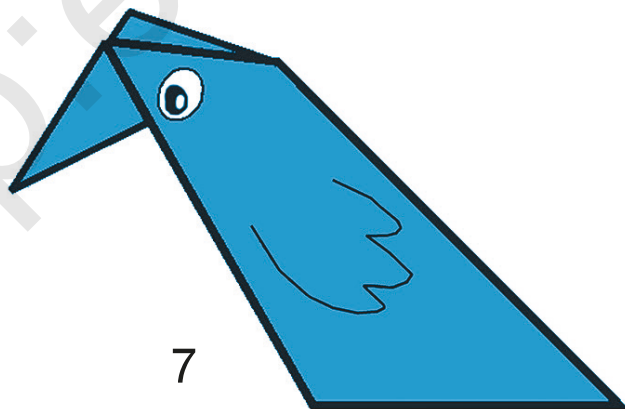

7



# BAQLAW JUMÍSÍ USHÍN TAPSÍRMALAR ÚLGISI

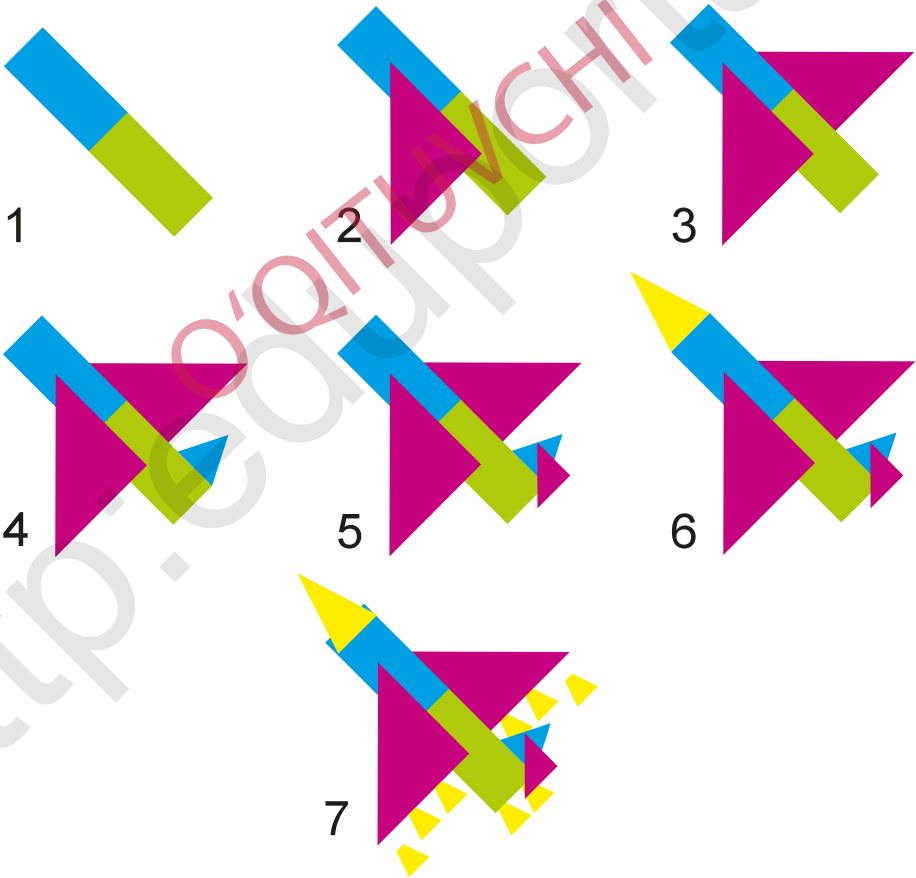

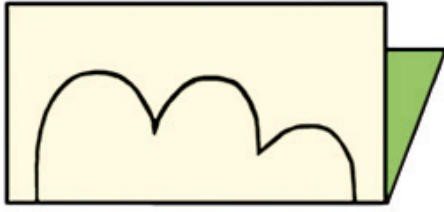

1

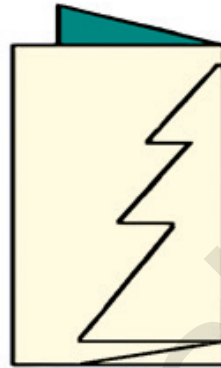

2

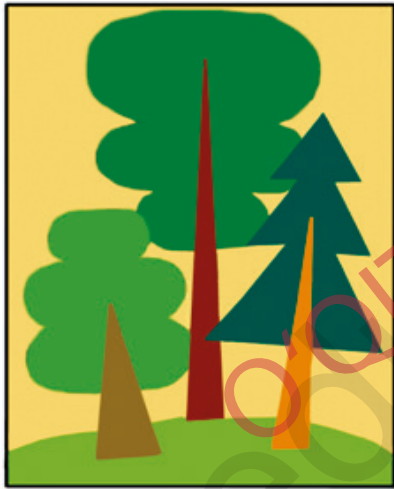

3



4



5

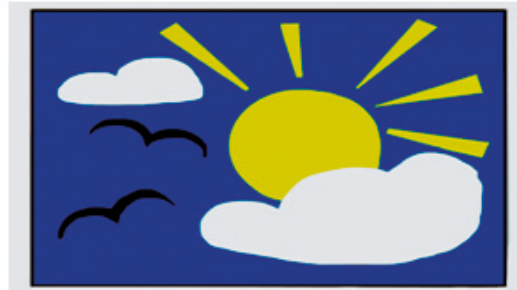

6

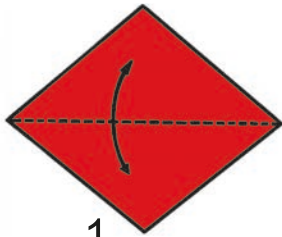

1



2



3

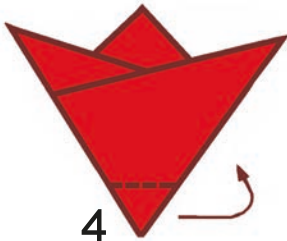

4



5



6

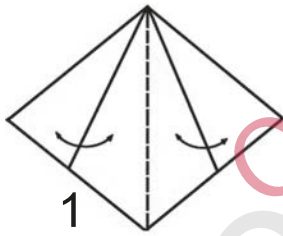

1



2



3



4

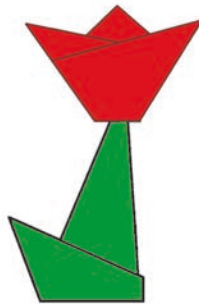

5

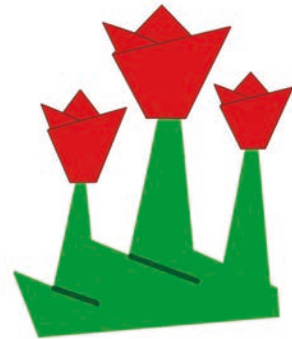



## KÁSIP USTALARÍ GÚRRIŃ ETEĐI

### ORNAMENT HÁM NAĞÍS

**Ornament** dep, arxitektura hám ámeliy kórkem óner shıǵarmalarındaǵı tiykarǵı elementlerden birine ayıladı. Ol sızıqlar hám reńlerden ibarat bolıp, imarat hám buyımlardı boyaw, tesiw hám oyıp islew jolı menen jaratıladı.

**Naǵıs** bolsa hár qıylı buyımlar, mebeller, úylerge oyıp hám boyap salınatúǵın gúl bolıp esaplanadı. Úyler, hár qıylı buyım hám mebellerge oyıp islew beriwshi hám de reńli boyawlar menen bezetiwshi xudojnik **naǵıs oyıwshı** dep ataladı.

Ózbekstanda naǵıs oyıwshılıq óneri áyyemnen rawajlanıp kiyatır. Ájayıp estelikler házirgi kúnge shekem óziniń kórkem kórinisin joǵaltpaǵan. Ulıwma, naǵıs gúl bezegi degen mánini ańlatadı.



## QAĞAZ

Mektepti qağazsız kóz aldımızğa keltiriw júdá qıyn. Dápter, kitap, klass jurnalı, kúndelik dápter qağazdan tayarlanadı. Qağaz turmısımızda áhmiyetli rol oynaydı. Bir bet qağaz tayarlaw ushın qanshadan-qansha insan miyneti talap etiledi. Qağazdı birinshi bolıp qıtaylılardan Cay Lun balıqshılıq torınan tayarlap kórgen. Bul áhmiyetli oylap tabılıw tek ğana Qıtay emes, bálkim pútkil adamzat ushın úlken áhmiyetke iye boldı. Ózbekstanda Temuriyler húkimdarlıǵı dáwirinde qağaz islep shıǵarıwǵa ayırıqsha áhmiyet berilgen. Sol sebepli de Samarqand qağazı Orta ásir Shıǵıs kalligrafları arasında oǵada qádirlegen, belgili bólegi bolsa sırt ellerge de tarqalǵan. Qağaz islep shıǵarıw texnologiyası mın jıldan artıq tariyxqa iye bolsa da, ol házirge shekem rawajlanıwda dawam etpekte.



## QAYSHÍ

Arxeologlar tárepinen qarabaxanalar-dan tabılǵan qayshı eń áyyemgi qayshılardan bolıp, onıń jası 3–4 mıń jıllarǵa tuwrı keledi. Bul qayshı dáslep adamnıń ózine xızmet etiw ushın emes, bálkim qoydıń júnin qırqıw ushın oylap tabılǵan.

Ol ózgerissiz eki mıń jıldan kóbirek waqıt dawamında qollanılıp kelingen.

Sonnan keyin, shama menen 1000 jil aldın, ónermentler eki pıshaqtı burama shege menen birlestirip hám olardıń bántin halqalarǵa aylandıırıp, qayshını qolaylı kóriniste oylap tapqan. Keyin ala qayshınıń dúzilisin jetilistirip bariw nátiyjesinde ol shashtárezler hám shıpakerlerdiń jumıs qurallarına aylanǵan. Hár bir usta óziniń qayshısın jetilistirip barǵan. Usı sebepli arnawlı qayshılar payda bolǵan. Máselen: baǵban, shashtárez, tigiwshi, xirurg qayshıları hám basqalar.



## APPLIKACIYA

**Applikaciya** latin tilinde «biriktiriw» degen mánini ańlatadı. Bul áyyemgi kórkem óner túrлерinen biri bolıp esaplanađı. Applikaciya qaǵaz, karton yaki gezleme bólimлерinen, keptirilgen gúller hám japıraqlardan jabıstırıw arqalı jaratıladı. Hár bir xalıqtıń aplikaciyası forması, reńi hám ózgesheligi menen birbirinen parıqlanađı.



## ORIGAMI

**Origami** «taqlaw hám búklew» degen mánini bildiredi. Origami texnologiyasında qayshı qollanılmaydı. Origami óneri Yaponiyada qaǵaz islep shıǵarıw dáwirinen baslap rawajlanıp kelgen. Orta ásirlerde ol yapon aqsúyekleri mádeniyatınıń bir bólegine aylanǵan. Házirgi kúnde origami texnologiyası menen shuǵıllanıw tek ǵana Yaponiyada emes, bálkim pútkil dúnyada adamlardıń súyikli dem alıw shınıǵıwlarına aylanǵan.

## MAZMUNÍ

1- sabaq. TEXNOLOGIYA PÁNI HAQQÍNDÁ TÚSINIK.....	3
2- sabaq. «ALTÍN GÚZ» KÓRINISIN SOGÍW.....	8
3 - sabaq. JAPÍRAQLARDAN NAGÍS KOMPOZICIYASÍN JARATÍW.....	11
4 - sabaq. JAPÍRAQLARDAN QUSTÍN FORMASÍN SOGÍW .....	13
5 - sabaq. JAPÍRAQLARDAN HAYWANLAR FORMASÍN SOGÍW .....	15
6 - sabaq. JAPÍRAQLARDAN QUSLARDÍ SOGÍW.....	17
7- sabaq. TABIYIY HÁM HÁR TÚRLI MATERIALLARDAN QUSLARDÍ SOGÍW .....	18
8 - sabaq. TÁBIYIY HÁM HÁR TÚRLI MATERIALLARDAN KOMPOZICIYA JARATÍW .....	19
9 - sabaq. TUQÍMLARDÍ JÍYNAW HÁM SAQLAW .....	20
10 - sabaq. TUQÍMLARDAN NAGÍS SOGÍW .....	21
11- sabaq. BALÍQTÍN FORMASÍN SOGÍW .....	23
12 - sabaq. ROMASHKA GÚLIN SOGÍW.....	24

13 - sabaq. QAĞAZ HÁM ONÍN TÚRLERI .....	27
14 - sabaq. KITAP USHÍN BELGI SOĞÍW .....	32
15 - sabaq. QAĞAZDAN KÚSHIK SOĞÍW.....	34
16 - sabaq. BAYRAMLAR USHÍN NÍQAPLAR TAYARLAW .....	36
17- sabaq. QAĞAZDAN OYÍNSHÍQLAR SOĞÍW .....	39
18 - sabaq. QÍS KÓRINISIN APPLIKACIYA USÍLÍNDÁ ISLEW .....	42
19 - sabaq. REÑLI QAĞAZDAN JANÍWARLARDÍN FORMASÍN QURASTÍRÍW-SOĞÍW .....	45
20 - sabaq. QAĞAZDAN TÚLKINIÑ FORMASÍN QURASTÍRÍW-SOĞÍW .....	47
21- sabaq. MOZAIKA HAQQÍNDÁ TÚSINIK.....	49
22- sabaq. MOZAIKA USÍLÍNDÁ PALÍZ ÓNIMLERI NÍN FORMASÍN SOĞÍW .....	50
23 - sabaq. DIZAYNERLIK KÁSIBI.....	52
24 - sabaq. NAWRÍZ BAYRAMÍNA QUTLÍQLAW- NAMA TAYARLAW .....	54

25 - sabaq. GEOMETRIYALIQ FORMADAĞÍ QAĞAZ- LARDÍ QÍYÍW USÍLLARÍ .....	56
26 - sabaq. GEOMETRIYALÍQ FIGURADAĞÍ QAĞAZ- LARDAN HÁR TÚRLI HAYWANLARDÍN FORMASÍN SOĞÍW .....	57
27- sabaq. GEOMETRIYALÍQ FORMADAĞÍ QAĞAZ- DAN MASHINA QURASTÍRÍW SOĞÍW .....	60
28 - sabaq. MIYWE HÁM PALÍZ ÓNIMLERIN SIMME- TRİYALÍ FORMALARDAN SOĞÍW .....	62
29 - sabaq. QURÍLÍSSHÍ KÁSIBI .....	64
30 - sabaq. QAĞAZDAN «SEBETDEGI GÚLLER»DI QURASTÍRÍW-SOĞÍW .....	67
31- sabaq. QAĞAZDAN BÚKLEW USÍLÍNDÁ HAYWANLAR, QUSLARDÍN FORMASÍN SOĞÍW .....	69
BAQLAW JUMÍSÍ USHÍN TAPSÍRMALAR ÚLGISI .....	70
KÁSIP USTALARÍ GÚRRÍN ETEDI .....	73

74.200.52  
M 37

**Mannopova I.**

**Texnologiya:** 1-klass ushın sabaqlıq / I. Mannopova, R. Mavlonova, N. Ibragimova. – Tashkent: «O‘qituvchi» BPDÚ, 2019. – 80 bet.

ISBN 978-9943-22-345-5

UO‘K: 373.3.016:331(075.2)

KBK 74.200.52

**Mannopova Ilgizar Ahmadovna  
Mavlonova Rahima Abdurazzoqovna  
Ibragimova Nazokat Ravshanxonovna**

## TEKNOLOGIYA

**1-sinf uchun darslik**

*(Qoraqalpoq tilida)*

Qayta ishlangan va to‘ldirilgan besinshi nashri

«O‘qituvchi»

nashriyot-mabaa ijodiy uyi

Toshkent – 2019

Awdarmashi *Sveta Baynazarova*

Redaktor *Sulıwxan Aytmuratova*

Kórkem red. hám xudojnik *Shohrux Toshturdiyev*

Dizayner *Oleg Sava*

Texnik redaktor *Nazokat Niyozmuhamedova,*

Operator *Dusmatova Dilnoza*

Baspa licenziyası AI № 012. 20.07.2018.

30.04.2019-j.da basiwǵa ruqsat etildi. Formatı 70x90 <sup>1</sup>/<sub>16</sub>.

Kegli 18. Ofset usılında basıldı. Shártlı baspa tabaǵı 5,85. Esap baspa tabaǵı 5,00.

Nusqası 13.090. Buyırtpa №

Ózbekstan Respublikası Prezidenti Administraciyası janındaǵı

Málimleme hám ǵalaba kommunikaciya agentligi

«O‘qituvchi» baspa-poligrafıyalıq dóretiwshilik

úyi. Tashkent — 206, Yunusabad rayoni,

Yangishahar kóshesi, 1-úy.

Shártname № 13-19